



Manual for installation,  
use and maintenance

---

**MXC030FR**

**MXC060FR**

Ceramic hobs

# Contents

3	Important information
6	Unpacking
7	Using your hob
9	Efficient use of your hob
11	Cleaning and maintenance
13	Troubleshooting
14	Fitting the hob
15	Installation
17	Mains electricity connection

**IMPORTANT: Please read this instruction manual carefully before installation or using the appliance for the first time. Failure to install this appliance, or to have it installed, as per the instruction manual could invalidate your warranty.**

**Any service calls relating to misuse or incorrect installation could incur a service charge.**

**Please check our website for up to date manuals, as new information and changes are sometimes added.**

# Important information

This appliance must only be used for the purpose for which it is intended, i.e. domestic cooking. Any other use could be dangerous and may lead to premature failure of the appliance.

The CDA Group Ltd. cannot be held responsible for injuries or losses caused by incorrect use or installation of this product. Please note that CDA reserves the right to invalidate the warranty supplied with this product following incorrect installation or misuse of the appliance.

Under no circumstances should any external covers be removed for servicing or maintenance except by suitably qualified personnel.

## User information

- The appliance and its accessible parts become hot during use. Care should be taken to avoid touching heating elements.
- This appliance may be used by children aged 8 or over and by people who have reduced physical, sensory or mental abilities or inadequate experience and/or knowledge, provided that they are supervised or have been instructed on how to use the appliance safely and have understood the resulting dangers.
- Do not allow anyone unfamiliar with the contents of this instruction manual to operate the oven.
- Do not use harsh cleaning agents or sharp metal objects to clean the door as they can scratch the surface potentially resulting in cracking or shattering of the glass.
- Take care when opening the oven door during or after a cooking cycle as hot steam may escape.
- Do not use the oven in the event of a technical fault. Any faults must be fixed by an appropriately qualified and authorised person.
- In the event of an incident due to a technical fault, disconnect the power and report the fault to CDA Customer Care.
- The appliance has been designed only for cooking, any other

use may invalidate your warranty and cause danger.

### **Appliance information**

Please enter the details on the appliance rating plate below for reference, to assist CDA Customer Care in the event of a fault with your appliance and to register your appliance for warranty purposes.

<b>Appliance Model</b>	
------------------------	--

<b>Serial Number</b>	
----------------------	--

### **EU Declarations of Conformity:**

This appliance has been manufactured to the strictest standards and complies with all applicable legislation and the following European Directives.

- The Low Voltage Directive 2014/35/EU
- Electromagnetic Compatibility Directive 2014/30/EU
- ErP Directive 2009/125/EU

The product has been marked with the **CE** symbol and the Declaration of Conformity has been issued to the manufacturer and is available to the competent authorities regulating the market

### **IMPORTANT INFORMATION FOR CORRECT DISPOSAL OF THE PRODUCT IN ACCORDANCE WITH EC DIRECTIVE 2012/19/EU.**

At the end of its working life, the product must be taken to a special local authority waste collection centre or to a dealer providing appliance recycling services.

Disposing of a household appliance separately avoids possible negative consequences for the environment and health. It also enables the constituent materials to be recovered, saving both

energy and resources. As a reminder of the need to dispose of household appliances separately, the product is marked with a crossed-out wheeled dustbin .

**Please note:**

- Ceramic hobs become hot and remain hot during and immediately after use. Do not touch the hob until it has been allowed to cool.
- Keep children away from the appliance when in use.
- Never use the hob top for storage.
- Pan handles should never stand out beyond the edge of the worktop. This will help to avoid children reaching them.
- Do not lean over the hob when it is in use.
- Follow the cleaning instructions carefully.
- Ensure the base of the saucepan is clean and dry before placing it on the hob.
- Avoid hard shocks from cookware – the vitroceramic glass surface is highly resistant but not unbreakable.
- Do not place hot lids flat on the hob top. A “suction” effect could cause damage to the hob.
- Do not drag cookware across the hob top: in the long term, this could cause damage to the hob.
- Do not store cleaning or flammable products in the unit below the hob.
- Always use appropriate cookware.
- Do not cook unopened tins of food directly on the hob.
- Never put cooking foil or plastic materials on the ceramic surface when the hob is hot. These materials could melt and cause damage to the hob.
- Do not use the hob if the glass surface is cracked or damaged to prevent the risk of electric shock. Disconnect it from the power supply.
- Ensure that the power cable of a connected electrical appliance near the hob is not in contact with the cooking zones.
- This hob (Class 3) has been designed for use only as a cooking appliance. Any other use (e.g. heating rooms) should be

considered incorrect and therefore dangerous.

- The appliance is not intended to be operated by any means of an external timer or separate remote-control system.

## Important

- Do not use the hob if the glass surface is cracked or damaged to prevent the risk of electric shock. Disconnect it from the power supply.
- Ensure that the power cable of a connected electrical appliance near the hob is not in contact with the cooking zones.

## Unpacking

During transportation, protective packaging is used to protect the appliance against any damage.

- After unpacking, please dispose of all elements of packaging in a way that will not cause damage to the environment.
- All materials used for packaging the appliance are environmentally friendly; they are 100% recyclable and are marked with the appropriate symbol.
- **WARNING!** While unpacking, the packaging materials (polythene bags, polystyrene pieces, etc.) should be kept out of reach of children.

# Using your hob

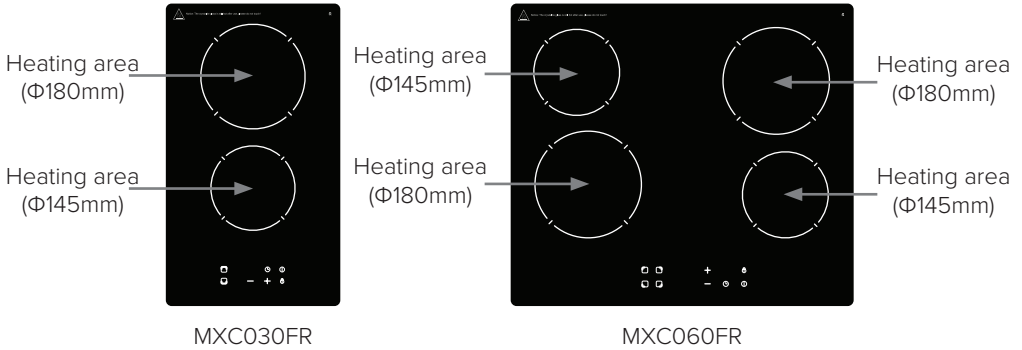

Model	Power Supply	Power (W)		Dimensions (mm)	Cut-out Size
		145mm	180mm		
MXC030FR	AC 220-240V 50Hz	1200W	1800W	300x520x53	282x496
MXC060FR		1200W	1800W		

## Touch Control

- All operations are performed by means of the touch controls on the control panel.
- Each touch control has a corresponding visual display (indicator light).
- You will hear a beep each time a touch is registered.

## Switching on the ceramic hob



1. Press the ON/OFF  button (fig. 1) to switch on the appliance.
2. The hob will beep once and all cooking zone indicators will light up briefly. Indicating that the hob has entered stand-by mode.



Fig.1

**Note:** Select a zone within one minute, otherwise the controller will automatically shut down.

## Switching on a cooking zone and setting a power level

1. Press the cooking zone select button  (fig. 2) for the zone you want to use.
2. Select the heat level required (1-9) by using the + and - buttons (fig. 3). By holding down either of these buttons, the

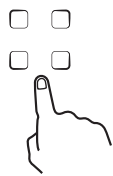

Fig.2



value on the heat level display will adjust up or down.

**Note:** When the power displays 0, press the down button, the power will set to 9.



Fig.3

### Switching off the ceramic hob



1. Press the ON/OFF  button, the hob will switch off. It is possible to turn the hob off at any time by pressing the ON/OFF  button.
2. Press the + and - buttons until the display shows 0, then the hob will switch off. After a zone is switched off, the corresponding heat level display will show a flashing letter "H".

This means that the temperature of the zone is above 60°C and is therefore still high enough to cause injury.

**Note:** When the temperature of the zone falls below 60°C the letter "H" will go out. It is still possible to burn yourself on a hob zone, even when its temperature has dropped below 60°C.

**IMPORTANT:** The residual heat indicator will disappear if the mains supply to the product is cut.

### Locking the ceramic hob

To lock the ceramic hob, press the safety lock button  (fig. 4) while the appliance is switched on. With the safety lock activated, all buttons on the control panel will be disabled, except the ON/OFF  button. To disable the safety lock feature, press the safety lock button  again. And you are then able to adjust the heat level of any zone on the hob.

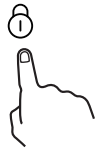

Fig.4

### Timer (99min timer mode)

Your hob has a timer which you can set (from 1 to 99 minutes) for each cooking zone. At the end of the countdown period, a buzzer will sound and the relevant cooking zone will be switched off.



- Select the cooking zone  (fig. 2) and heat level (fig. 3).
- Press the timer button  (fig. 5), and then use the + and - buttons to set the countdown time.
- Each time the + or - down button is pressed, the timer display will increase or decrease in 1 minute increments.



Fig.5

### Timer (15min timer mode)

Your hob has a timer which you can set (from 1 to 15 minutes) for



each cooking zone. At the end of the countdown period, a buzzer will sound and the relevant cooking zone will be switched off.

- Select the cooking zone (fig. 2) and heat level (fig. 3).
- Press the timer button (fig. 5), and then use the up and down buttons to set the countdown time.
- Each time the timer up or down button is pressed, the timer display will increase or decrease in 1 minute increments.

### **Safety cut-off**

If one or more of the cooking zones are accidentally left on, a safety cut-off will activate after a certain period of time. The length of time depends on the set power level for that zone. The table below gives the time limits for each power level.

If more than one zone is operating when one of the zones reaches its safety cut-off point, only the zone that has reached its safety cut-off point will switch off.

### **15min timer mode**

<b>Power level</b>	1	2	3	4	5	6	7	8	9
<b>Time limit (mins)</b>	15	15	15	15	15	15	15	15	15

### **99min timer mode**

<b>Power level</b>	1	2	3	4	5	6	7	8	9
<b>Time limit (hours)</b>	6	6	5	5	4	1.5	1.5	1.5	1.5

## **Efficient use of your hob**

Before using your hob for the first time, switch the zones on for a few seconds to burn off any grease left over from the manufacturing process.

The ceramic glass retains heat, so make the best use of the residual heat, switch off the zone five minutes prior to the end of cooking.

To reduce the cooking time, the zone can be set to the maximum setting at the beginning of cooking, and then reduced during cooking time.

The hob is equipped with zones of different sizes, designed to accommodate most shapes and sizes of pans. For the best results, only

use pans with flat bottoms. The most efficient use of the hob is shown below, where the pan and zone are correctly chosen. Use pan lids where possible to minimise the energy usage of your appliance.

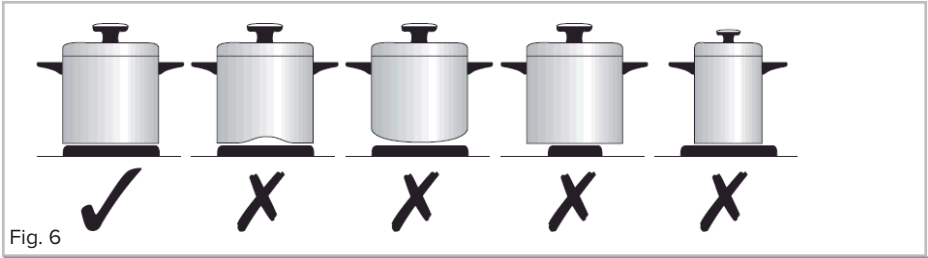

Fig. 6

Zone Size	Minimum Pan Size (mm)	Maximum Pan Size (mm)
145mm	130	160
180mm	160	200

It is very important that the pans used on the hob are made of a suitable material and have the correct type of base. The base should be flat and smooth, as any rough part on the pan base could scratch the ceramic hob top.

Choose pans which are between the sizes recommended in the table opposite, and with bases that are as non-reflective as possible, e.g. dull and dark.

Only pans recommended for use on ceramic hobs should be used.

Do not use pots and pans that are unsteady and likely to rock or overbalance.

Do not use enamel pots .

Do not operate the cooktop for an extended time without utensil on the hotplate.

**Please note:** Extra care should be taken if cast iron pans are used as these have coarse bases which may damage the hob top.

# Cleaning and maintenance

Always disconnect the appliance from the power supply before undertaking any cleaning or maintenance.

## Important:

- Steam cleaners must not be used when cleaning this appliance.
- You should use a non-abrasive cleaner to clean the hob top. Any abrasive cleaner (including Cif) will scratch the surface and could erase the control panel markings.
- Sugar and starch can cause permanent damage to the surface of the hob. Wipe away any spillages immediately but be careful given that the hob top will be hot during and after usage.
- Avoid letting pans boil over where possible to ensure that the need for cleaning is minimal.
- Always use a soft sponge or cloth where possible. Utensils such as scouring sponges and some brushes could cause scratches to the hob top.

**Please note:** A cleaning guide is available on page 11. When following the cleaning guide, please ensure any water or fluids do not encroach upon the control knobs as this may damage the hob.

Type of residue	Clean with	Cleaning advice
Light	Cleaning sponge and soft cloth	Wipe over the zone to be cleaned with a sponge and hot water, and then wipe off with a soft dry cloth.
Accumulated, baked-on stains/dirt, sugar spills or melted plastics	Cleaning sponge or glass scraper and soft cloth	Wipe over the zone to be cleaned with a sponge and hot water, using a ceramic scraper to remove any large marks or stains and then wipe off with a soft dry cloth.
Rings and hard water residues	White vinegar and soft cloth	Pour a small amount of warm white vinegar onto the stain, leave it to stand, and then wipe off with a soft dry cloth.
Shiny metallic streaks	Cleaning agent for vitroc ceramic glass	Use specialist vitroc ceramic glass cleaner (preferably one with silicone for its protective properties)

**If your hob is not working:**

1. Check that the zone is switched on.
2. Check that the mains supply has not been switched off.
3. Check that the fuse in the spur has not blown.

In the event of a fault with the hob please advise CDA Customer Care.

**Contact CDA Customer Care**

**A:** Customer Care Department, The CDA Group Ltd, Harby Road, Langar, Nottinghamshire, NG13 9HY

**T:** 01949 862 012

**F:** 01949 862 003

**E:** [customer.care@cda.co.uk](mailto:customer.care@cda.co.uk)

**W:** [www.cda.co.uk](http://www.cda.co.uk)

# Troubleshooting

Problem	Possible Causes	Possible Remedy
The appliance does not work and no indicators are lit.	The appliance has no power.	Check the RCD, hob power supply and fuse and replace fuse if blown.
The appliance switches itself off.	There is an issue with the installation or the internal wiring of the hob. The RCD has tripped.	Contact your installer if appliance is new.  Check if tripped, and reset RCD if necessary.
Residual heat indicator has extinguished despite zone(s) still being hot.	The appliance has no power. The temperature of the zone is below the acceptable threshold (approximately 50°C).	Check the fuse and replace if blown. Avoid touching the ceramic surface directly for some time after use.
Hob top is broken, cracked and/or chipped.	Stop using the appliance immediately and switch the appliance off at the mains. Contact CDA Customer Care to arrange a repair (contact details on page 11).	
A fault has not been resolved by any suggested remedies.	Contact CDA Customer Care using the contact details on page 11 to arrange a service visit.	

**Should the above steps not resolve an issue, please contact CDA Customer Care for assistance. Contact details are on page 12.**

**IMPORTANT - PLEASE NOTE:** In the event of any breakage, crack or cracking – even minimal – of the glass, immediately disconnect your hob to prevent a risk of electric shock and contact CDA Customer Care.

# Fitting the hob

## Unpacking the hob

Take care not to lose or mishandle any parts.

## Fitting position of the hob

This appliance must be installed a minimum of 50mm from any back wall and a minimum of 55mm away from any adjacent vertical non-combustible surfaces, e.g. a tall cupboard end panel, including adjacent surfaces that are resistant to fire (tiles or steel, for example). These dimensions are shown in Fig. 7.

## If fitting a cooker hood above the hob

If a cooker hood is to be installed above the hob, the height of the hood above the hob must be at least 600mm (650mm is recommended) (Fig. 8). If the instructions supplied with the hood dictate that the hood must be installed at a height greater than 600mm, then that height is the minimum required.

## Wall furniture requirements

The minimum height of any cabinet immediately above the hob is 600mm. The minimum height of any adjacent units (including light pelmets) is 400mm, unless they are manufactured from a material resistant to fire (steel, for example).

## Notes

- Do not position this appliance above a refrigeration unit. The heat generated may cause the refrigeration unit to fail.
- This appliance is designed to be installed into cabinet units capable of withstanding temperatures of 65°C or greater above ambient temperature.
- Never place perishable foods, soft items such as tea towels, cleaning products or flammable items in the cupboard or drawer below the appliance.
- If an oven is to be installed below the hob, the thermal safety system on the hob may not allow the hob to be used at the same time as a pyrolytic programme on the oven.
- The hob is equipped with an anti-overheating safety device that can be activated if the hob is installed over an oven that is not sufficiently

vented. In the event that this occurs, we recommend that you increase the ventilation of the hob by creating an opening in the side of the cabinet (8cm x 5cm).

Adjacent vertical non-combustible surface (cupboard etc., measurement applicable to both sides)

Fig. 7

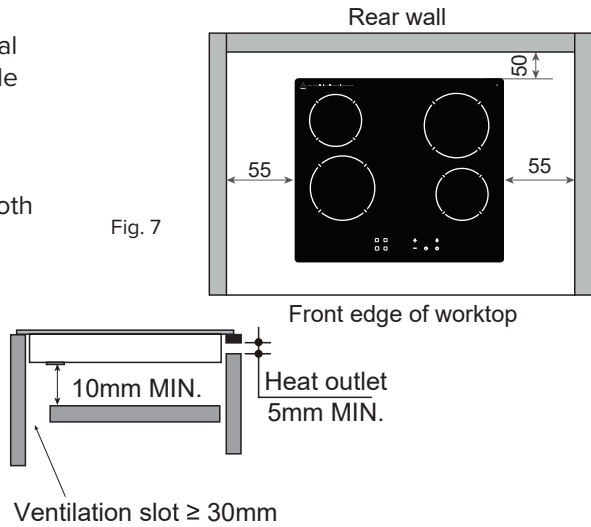

## Installation

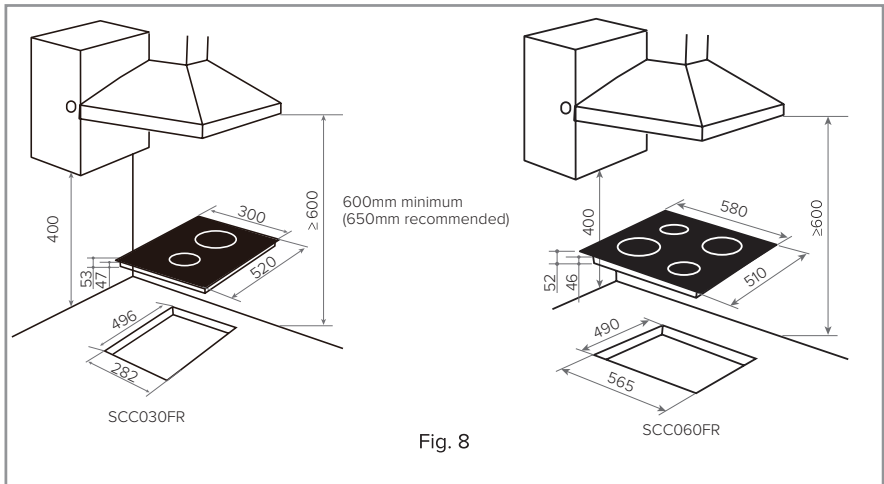

1. Make the required hole in the worktop. Ensure the thickness of the work surface is at least 20mm. Before doing this, you must check the instructions supplied with any cooker hood to ensure that you

will have the required clearance. The distance from the hob, when fitted, to the back wall must be a minimum of 50mm. If a splash-back/worktop upstand is to be fitted, take this into account when cutting the hole.

The minimum distance that the hob should be positioned away from the rear wall or splashback is 50mm.

2. Position the hob seal, as shown in Fig. 9, ensuring that the ends meet without overlapping. Do not use silicone type sealant.

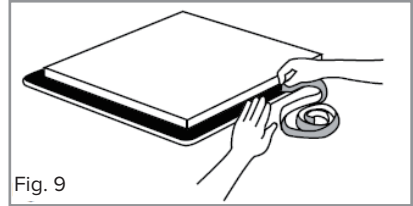

3. Attach the four supplied fixing clips to the sides of the hob (Fig. 10).

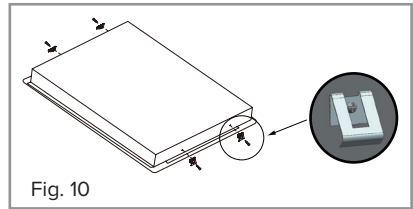

4. Make sure that the worktop is clean and dust free and insert the hob into the cut-out opening Fig. 11. Press the hob firmly into place so that the seal connects with the worktop.

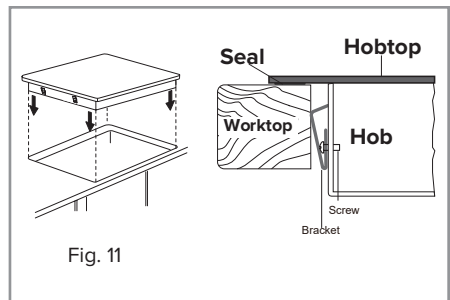



# Mains electricity connection

**Warning! This appliance must be earthed.**

This appliance must be connected by a qualified electrician, or a similarly competent person, who is a member of the N.I.C.E.I.C. and who will comply with the I.E.T. and local regulations.

**This appliance is intended to be connected to fixed wiring and is not suitable for connection to a 13A plug or 13A supply.**

**This appliance is intended to be connected to fixed wiring by a double pole switch, having a contact separation of at least 3mm in all poles. The switch must be positioned no further than 2m from the appliance.**

## **Please note:**

- The mains cable must only be replaced by a qualified electrician or service engineer and must be of equivalent or better rating (i.e. 4mm<sup>2</sup>, HO5VV-F).
- This appliance is intended to be connected to the mains supply with a cable of cross sectional area (MXC030FR—1.5mm<sup>2</sup>, MXC060FR—4mm<sup>2</sup>).
- The current rating of the fuse or circuit breaker protecting this appliance should be marked on the socket outlet.
- Assembly and electrical connection should be carried out by specialised personnel.
- When installing this product we recommend you seek the help of another individual.
- Should the mains cable be damaged or need to be replaced, it should only be done so by a qualified electrician or engineer. The hob connections are shown on the next page:

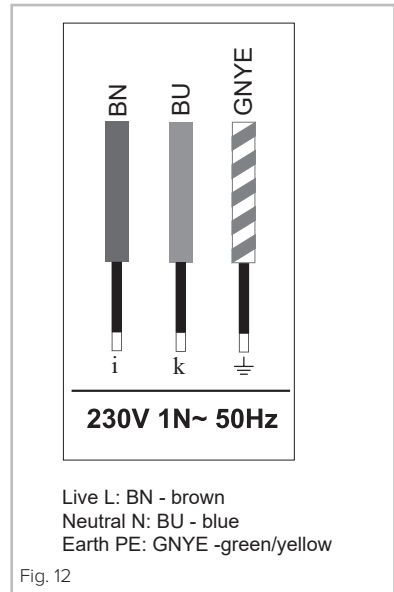

## Connection Diagrams

**CAUTION!** Voltage of heating elements 220-240V

**CAUTION!** In the event of any connection, the safety wire must be connected to the ⊕ E Terminal

For 220-240V earthed one-phase connection, bridges connect L1-L2 terminals and N1-N2 terminals, safety wire to ⊕

Ensure that the brass links are securely fitted. Failure to do so may prevent the hob from operating correctly.

MXC030FR

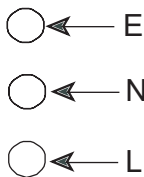
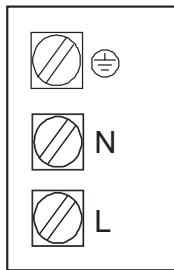

MXC060FR

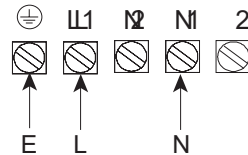
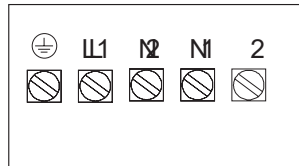

# Notes



Serviced by



For our Customer Care Department, or for Service,  
please contact us on: